

Mi·Light[®]

RGB+CCT LED Garden Light (Subordinate Lamp)

Model No.: SYS-RC1 / SYS-RC2

This product has to be connected to "SYS-T1 Controller" to fulfill the remote controlling.

Features

The housing of this product is made of die-cast aluminum, and the lens is made of transparent PC; no astigmatism, no shadow, elegant and delicate. We use silicone rubber to seal the light to assure the super waterproofness, waterproof rating is IP66. Connecting with host controller(SYS-T1), you can wireless control the 16million color changing, color temperature, brightness and saturation. Create a beautiful lighting environment for you. Widely used on landscape lighting including flowers, trees and lawn, etc.



RGB+CCT
16 Millions of colors to choose



Dimmable
Saturation control



Color temperature
2700~6500K



Waterproof and dustproof
grade IP66



Beam Angle 15°, Illumination
distance Greater than 10m

Parameters

Model No.: SYS-RC1
Input Voltage: DC24V
Power: 9W
Working Temperature: -20~60°C
Color temperature: 2700~6500K
Luminous Flux: 700LM
Light Efficiency: 80LM/W
CRI: >80
Lifespan: 50000h
Illumination distance: >10m
Beam Angle: 15°
IP Rate: IP66
Product Weight: 420g
Housing Material: Aluminum+stainless steel

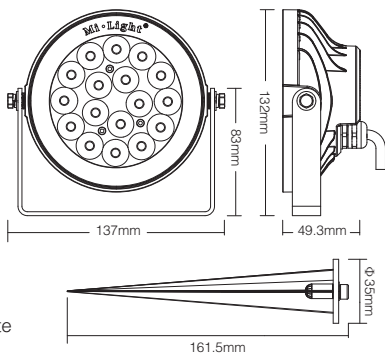

Parameters

Model No.: SYS-RC2
Input Voltage: DC24V
Power: 15W
Working Temperature: -20~60°C
Color temperature: 2700~6500K
Luminous Flux: 1200LM
Light Efficiency: 80LM/W
CRI: >80
Lifespan: 50000h
Illumination distance: >10m
Beam Angle: 15°
IP Rate: IP66
Product Weight: 710g
Housing Material: Aluminum+stainless steel

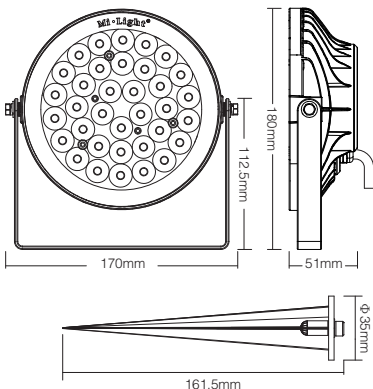

Connection Diagram

Note: The "SYS-T1 Controller" has to be purchased separately.

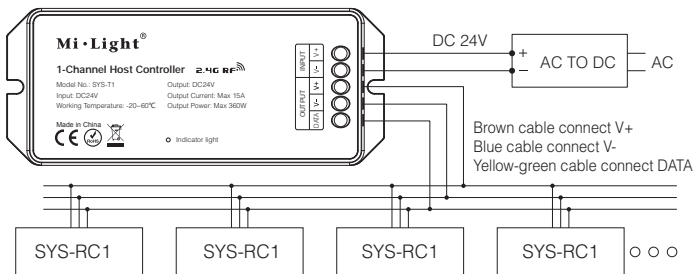

Note: When using "SYS-T1 controller", you need to add "SYS-T2 1-channel signal amplifier" for below 3 situations.

1. Connecting over 50pcs lights.
2. Connected cable length over 300m.
3. Output power over 360W.

Input: DC24V

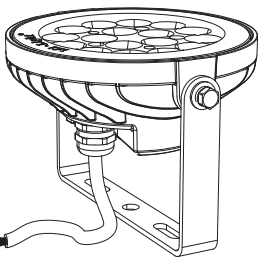
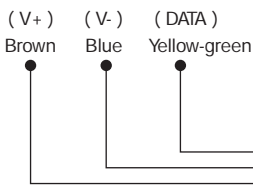

Attention

1. Please check whether the input voltage is in accordance with the lighting working voltage, and please check the connection of both the cathode and anode.
2. The working Voltage is DC24V, the lighting will be damage if the voltage is higher than 24V.
3. Non-professional user cannot dismantle the controller directly, Otherwise it may damage the light.